

Collezione Laccati
Lacquered Collection

**DOOR
BOOK
2026**



Al centro del nostro impegno c'è la sostenibilità e la qualità produttiva. Per noi produrre porte, significa farlo in maniera responsabile e certificata.

La tradizione che ci lega alla cultura del legno si consolida ogni giorno nella selezione delle migliori materie prime dai legni provenienti da boschi certificati a prelievo controllato contro la deforestazione.

La certificazione UNI EN ISO 9001:2015 garantisce un sistema interno dalle elevate performance qualitative che risponde a qualsiasi esigenza in ogni fase del processo di progettazione e realizzazione dei componenti della porta.

Ogni giorno produciamo porte con responsabilità per migliorare il benessere dei nostri collaboratori e dell'intero ambiente.

We take care about sustainability and production quality. For us, producing doors means doing so in a responsible and certified way. The tradition that binds us to the culture of wood is consolidated every day in the selection of the best raw materials from woods that come from certified forests with controlled harvesting against deforestation. UNI EN ISO 9001:2015 certification guarantees an internal system with high quality performance that meets any requirement at every stage of the design and manufacturing process of door components.

Every day we produce doors with responsibility to improve the well-being of our employees and the entire environment.





Porte Imic, nata in Sicilia a Torrenova nel 1956 come bottega artigianale, si presenta oggi al mercato come emblema di eleganza e raffinatezza del Made in Italy e del design italiano.

Grazie al controllo dell'intero processo produttivo, dalla materia prima al prodotto finito, alla tecnologia di ultima generazione unitamente alla manualità dell'uomo, garantiamo l'elevato standard qualitativo per rispondere alle esigenze del mercato sempre più attento ai dettagli e alle nuove tendenze.

Il know how acquisito in questi anni ci permette di offrire una vasta gamma di modelli e soluzioni in grado di contribuire a dare identità e carattere estetico all'abitare contemporaneo.

Imic Doors, founded in Sicily in Torrenova in 1956 as a craft workshop, now presents itself to the market as an emblem of elegance and refinement of Made in Italy and Italian design. Thanks to the control of the entire production process, from raw material to finished product, state-of-the-art technology together with human dexterity, we guarantee the high quality standard to meet the needs of the increasingly detail-oriented market and new trends.

The know-how acquired over the years enables us to offer a wide range of models and solutions that can contribute identity and aesthetic character to contemporary living.

INDICE

INDEX

- 8 Geometrika
- 30 Seventy
- 60 Line
- 126 Place
- 150 Double
- 160 Mimesy
- 194 Finiture Finishes
- 196 Maniglie Handles
- 198 Cerniere Hinges
- 200 Informazioni tecniche Technical Data Sheets

GEOMETRIKA

Anta Pantografata **Pantographed door**

Un'interpretazione della porta classica in chiave moderna, valorizzata dalla morbidezza della laccatura.

A contemporary take on the traditional door, enhanced by a smooth lacquered finish.

Modello 700 GV
Con vano vetro
Laccato Bianco Opaco
Model 700 GV
With cut-out for glass
Lacquered Matt White

Modello 700 G
Laccato Bianco Opaco
Model 700 G
Lacquered Matt White



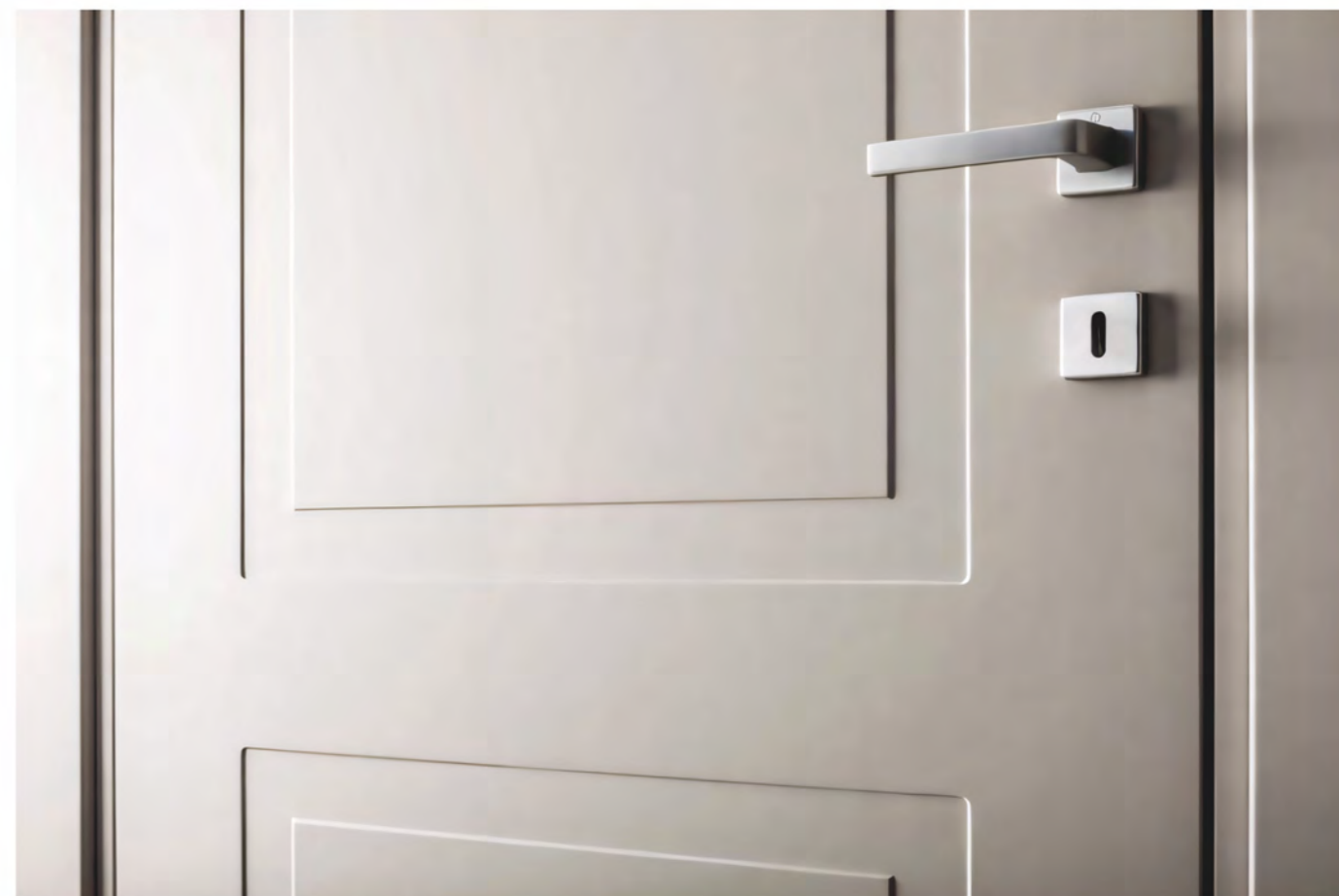

Modello 702 G altezza 240 cm
Laccato Bianco Opaco
Complanare con apertura inversa
Model 702 G height 240 cm
Lacquered Matt White
Coplanar with reverse opening



Modello 703 G
Laccato Tortora
Model 703 G
Lacquered Brown Beige

Modello 703 GV
Con vano vetro
Laccato Tortora
Model 703 GV
With cut-out for glass
Lacquered Brown Beige







Modello 850 G
Laccato Bianco Opaco
Model 850 G
Lacquered Matt White





Modello 900 GV
Con vano vetro
Laccato Bianco Opaco
Model 900 GV
With cut-out for glass
Lacquered Matt White

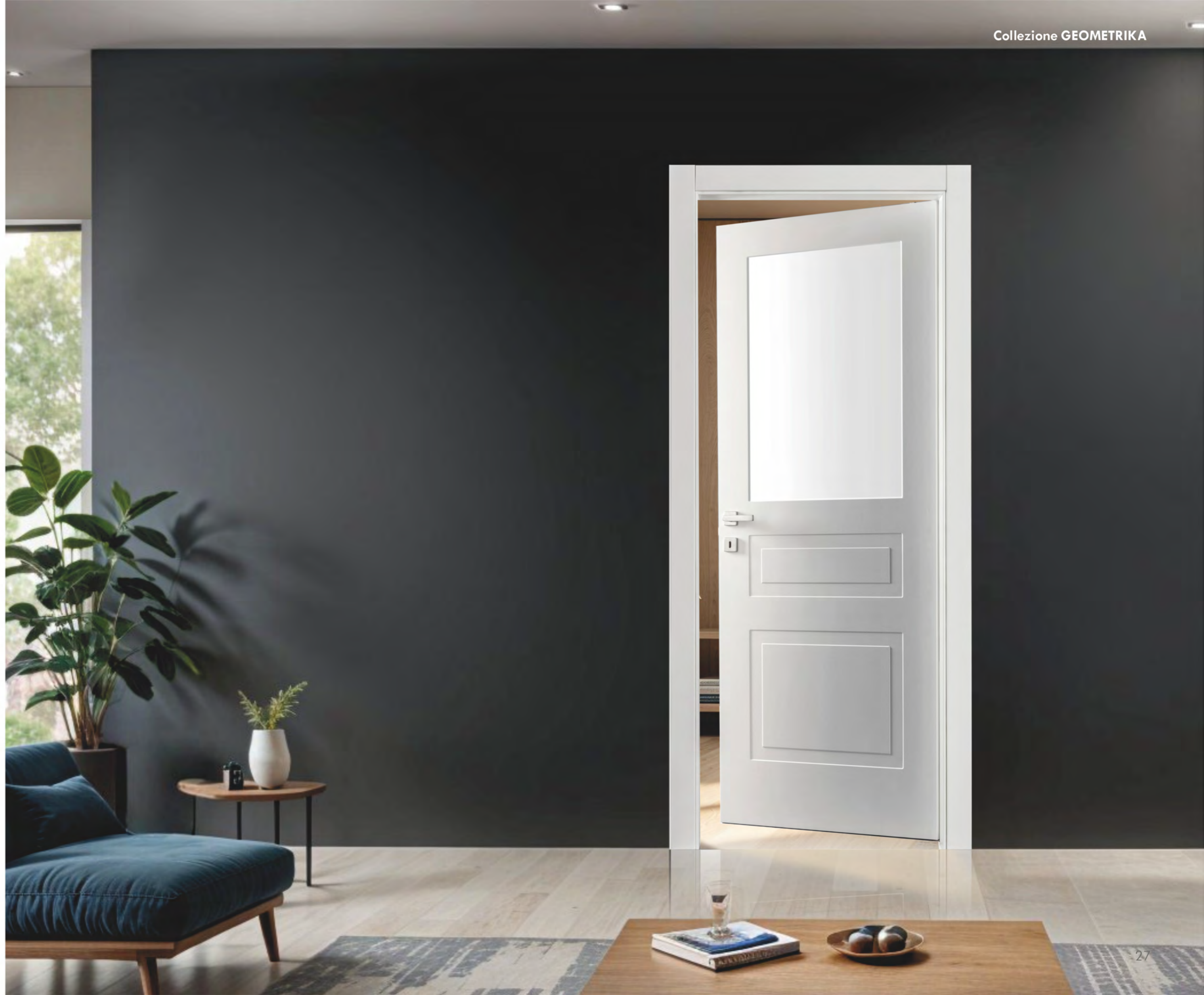

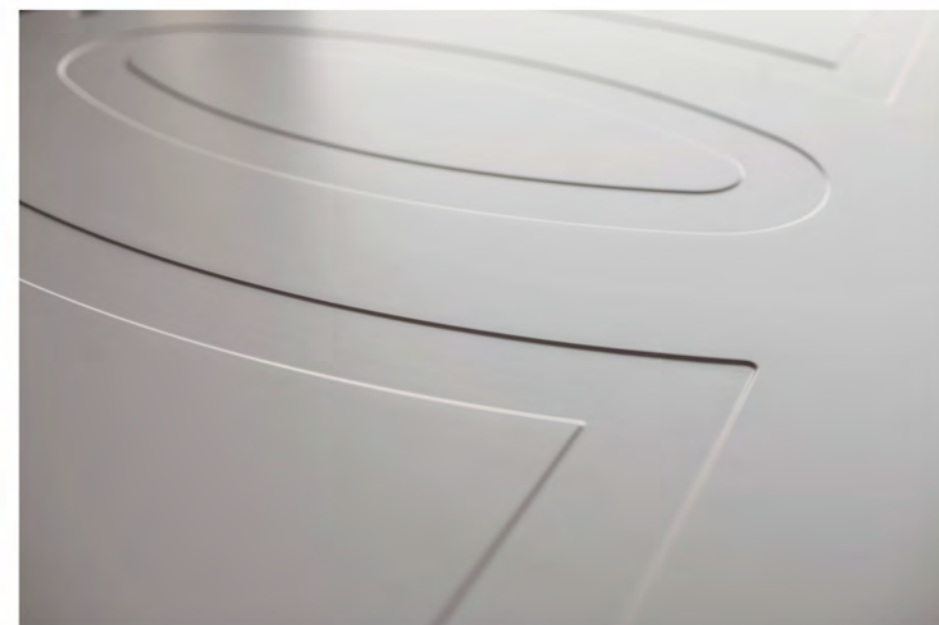

Anta Pantografata
Pantographed door

Una porta che evoca sensazioni di leggerezza e compattezza, dove l'elemento decorativo 'la pantografatura minimal' diventa essenziale nella definizione estetica.

A door recalls grace and stability, where the 'minimal pantographed effect' becomes the distinguishing features.



Modello 210 PV
Laccato Bianco Opaco con vetro satinato
Model 210 PV
Lacquered Matt White with satin glass







Modello 240 P
Laccato Blu Grey
Model 240 P
Lacquered Blue Grey





Modello 240 P
Laccato Grigio Lava
Model 240 P
Lacquered Grey Lava



Modello 240 PV
Laccato Grigio Lava con vetro satinato
Model 240 PV
Lacquered Grey Lava with satin glass





Modello 250 PV altezza 240 cm
Laccato Blu Denim con vetro satinato
Model 250 PV height 240 cm
Lacquered Blue Denim with satin glass



Modello 260 P altezza 260 cm
Laccato Tortora
Complanare con apertura inversa
Model 260 P height 260 cm
Lacquered Brown Beige
Coplanar with reverse opening







Collezione SEVENTY

Modello 290 P
Laccato Tortora
Model 290 P
Lacquered Brown Beige

Modello 290 P
Laccato Grigio Luce
Rototraslante
Model 290 P
Lacquered Light Grey
Swing door



LINE

Anta Incisa
Door leaf with lines

Un'estetica basata su linee che scompongono la superficie primaria conferendole semplicità e eleganza.

Horizontal lines engrave on a plain surface lend simplicity and elegance.





Modello 100 L
A Bilico
Laccato Grigio Lava
Model 100 L
Pivot
Lacquered Grey Lava



Modello 100 L altezza 260 cm
Scorrevole esterno muro "Magic"
Laccato Grigio Lava
Model 100 L height 260 cm
Sliding door "Magic" system
Lacquered Grey Lava



Modello 100 L altezza 260 cm
Scorrevole esterno muro "Magic" con maniglia a gola
Laccato Tortora
Model 100 L height cm 260
Sliding door "Magic" system with groove handle
Lacquered Brown Beige



Modello 100 L LB
A libro con ante asimmetriche
Laccato Bianco Opaco
Model 100 L LB
Folding with asymmetrical leaves
Lacquered Matt White



Modello 100 L
Complanare con apertura inversa
Laccato Bianco Opaco
Model 100 L
Coplanar with reverse opening
Lacquered Matt White



Modello 100 TL
Laccato Bianco Opaco
Model 100 TL
Lacquered Matt White





Modello 110 L
Laccato Bianco Opaco
Model 110 L
Lacquered Matt White





Modello 111 LV
Con vetro satinato
Laccato Bianco Opaco
Model 111 LV
With satin glass
Lacquered Matt White



Modello 125 L
Laccato Bianco Opaco
Model 125 L
Lacquered Matt White



Modello 125 L altezza 260 cm
Scorrevole esterno muro "Magic"
Laccato Bianco Opaco
Model 125 L height 260 cm
Sliding door "Magic" system
Lacquered Matt White



Modello 130 L
Laccato Bianco Opaco
Model 130 L
Lacquered Matt White





Modello 140 LV
Con vetro satinato
Laccato Bianco Opaco
Model 140 LV
With satin glass
Lacquered Matt White

Modello 140 L
Laccato Bianco Opaco
Model 140 L
Lacquered Matt White

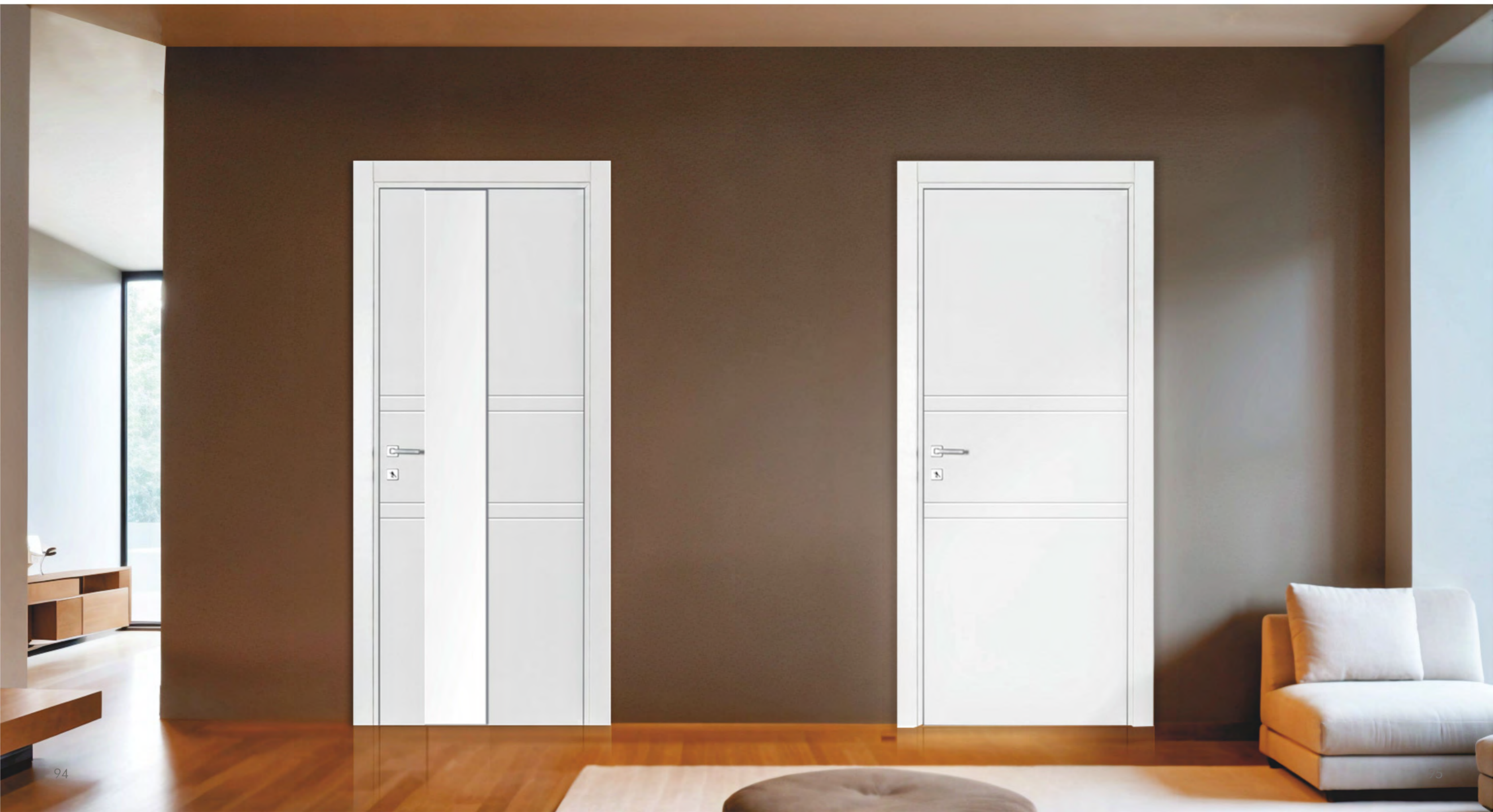







Modello 165 L
Laccato Bianco Opaco
Model 165 L
Lacquered Matt White









Modello 180 LV
Con vetro satinato
Laccato Grigio Luce
Model 180 LV
With satin glass
Lacquered Light Grey

Modello 180 L
Laccato Grigio Luce
Model 180 L
Lacquered Light Grey



Modello 185 L
Laccato Wine
Model 185 L
Lacquered Wine



Modello 190 L
Laccato Bianco Opaco
Model 190 L
Lacquered Matt White





Modello 215 L altezza 240 cm
Laccato Verde Mineral
Model 215 L height 240 cm
Lacquered Mineral Green



Modello 270 LV
Con vetro satinato
Laccato Bianco Opaco
Model 270 LV
With satin glass
Lacquered Matt White



Modello 470 LV 1
Con vetro satinato
Laccato Bianco Opaco
Model 470 LV 1
With satin glass
Lacquered Matt White



Modello 470 LV 2
Con vetro satinato
Laccato Bianco Opaco
Model 470 LV 2
With satin glass
Lacquered Matt White



PLACE

Anta Pantografata Pantographed door

Unisce l'utilizzo intelligente della tecnologia al design classico per produrre immagini con effetto visivo tridimensionale che trasmettono piacere ed emozione.

The smart use of technology is combined with a classic design: it creates figures with three dimensional visual effects that produce pleasant sensations.

Modello 700 PV
Con vano vetro
Laccato Bianco Opaco
Model 700 PV
With cut-out for glass
Lacquered Matt White

Modello 700 P
Laccato Bianco Opaco
Model 700 P
Lacquered Matt White









Model 800 PV
Con vano vetro
Laccato Bianco Opaco
Model 800 PV
With cut-out for glass
Lacquered Matt White





Modello 900 P
Laccato Bianco Opaco
Model 900 P
Lacquered Matt White



Modello 900 P
Con capitello Imperial (Optional)
Laccato Bianco Opaco
Modello 900 P
With Imperial capital (Optional)
Lacquered Matt White



Modello 900 P
Con coprifilo Royal (Optional)
Laccato Bianco Opaco
Model 900 P
With Royal architrave (Optional)
Lacquered Matt White



Modello 900 PV
Con vano vetro
Laccato Bianco Opaco
Model 900 PV
With cut-out for glass
Lacquered Matt White



Modello 1500 P
Laccato Avorio
Model 1500 P
Lacquered Ivory



Modello 1600 P
Laccato Bianco Opaco
Model 1600 P
Lacquered Matt White



DOUBLE

Un'esplosione di modernità,
accentuata dalla scanalatura
doppia.

*Our double groove effect is
an explosion of contemporary
design.*









MIMESY

Porta filomuro Flush to wall

NATA PER ESSERE INVISIBILE

L'ambiente domestico oggi viene considerato sempre come un tutt'uno. Per questo la porta acquisisce ulteriori connotati che non riguardano solo il design, i materiali impiegati, ma anche l'idea di armonizzarsi con ciò che ci circonda.

BORN TO BE INVISIBLE

today, the home environment is considered as a single, seamless whole. For this reason, the door acquires additional meaning that go beyond design and materials, it also embodies the idea of blending harmoniously with everything that surrounds us.



Modello 100 L altezza 270 cm
Laccato Corten
Model 100 L height 270 cm
Lacquered Corten



Modello 100 L altezza 260 cm
Con maniglia Wave
Laccato Corten
Model 100 L height 260 cm
With handle Wave
Lacquered Corten



Modello 100 L altezza 260 cm
con maniglia push a filo
Laccato Bianco Opaco
Model 100 L height 260 cm
with flush push handle
Lacquered Matt White



Modello 100 L altezza 240 cm
con maniglia a gola
Laccato Bianco Opaco
Model 100 L height 240 cm
with groove handle
Lacquered Matt White





Modello 100 L altezza 270 cm
Con maniglia a gola
Laccato Bianco Opaco
Model 100 L height 270 cm
With groove handle
Lacquered Matt White



Modello 125 L altezza 260 cm
Laccato Bianco Opaco
Model 125 L height 260 cm
Lacquered Matt White



Modello 160 L altezza 260 cm
Laccato Bianco Opaco
Model 160 L height 260 cm
Lacquered Matt White





Modello 175 L altezza 270 cm
Laccato Blu Grey
Model 175 L height 270 cm
Lacquered Blue Grey





Modello 215 L altezza 240 cm
Laccato Verde Mineral
Model 215 L height 240 cm
Lacquered Mineral Green





Modello 250 P altezza 240 cm
Laccato Blu Denim
Model 250 P height 240 cm
Lacquered Blue Denim



Modello 260 P altezza 260 cm
Laccato Tortora
Model 260 P height 260 cm
Lacquered Brown Beige



FINITURE FINISHES

Laccati Opaco Matt Lacquered



Bianco Opaco
Matt White

Grigio Luce
Light Grey

Avorio
Ivory

Blu Grey
Blue Grey

Tortora
Brown Beige



Grigio Lava
Lava Grey

Verde Mineral
Mineral Green

Wine
Wine

Blu Denim
Denim Blue

Albicocca
Apricot

Laccati Lucido Gloss Lacquered



Bianco
White

Grigio Luce
Light Grey

Avorio
Ivory

Blu Grey
Blue Grey

Tortora
Brown Beige



Grigio Lava
Grey Lava

Verde Mineral
Mineral Green

Wine
Wine

Blu Denim
Denim Blue

Albicocca
Apricot

Laccati Metallo Metal Lacquered



Corten
Corten

Oro Satinato
Satin Gold

Bronzo Satinato
Satin Bronze



Su richiesta è possibile avere colori a campione RAL
RAL colours available on request

MANIGLIE HANDLES



Standard
alluminio
aluminum



Standard
cromata in alluminio
chrome aluminum



Maribo
cromo satinato
satin chrome



Maribo
ottone lucido
polished brass



Vega
cromo satinato
satin chrome



Vega
ottone lucido
polished brass



Dublin
cromo satinato
satin chrome



Los Angeles
cromo satinato
satin chrome



Q-Arte
cromo satinato
satin chrome



Q-Arte
nero opaco
matt black



ICO
con rosetta quadra
nero opaco
with square rosette
matt black



ICO
con rosetta quadra
cromo satinato
with square rosette
satin chrome



KUBO
con rosetta
minimal quadra
nero opaco
with minimal
square rosette
matt black



KUBO
con rosetta
minimal quadra
cromo satinato
with minimal
square rosette
satin chrome



EASY
con rosetta tonda
cromo satinato
with round rosette
satin chrome



EASY
con rosetta tonda
nero opaco
with round rosette
matt black



EASY
con rosetta
minimal tonda
nero opaco
with minimal
round rosette
matt black



EASY
con rosetta
minimal tonda
cromo satinato
with minimal
round rosette
satin chrome



KUBO
con rosetta quadra
nero opaco
with square rosette
matt black



KUBO
con rosetta quadra
cromo satinato
with square rosette
satin chrome



SHAPE
cromo satinato
satin chrome



SHAPE
nero opaco
matt black



**A SCOMPARSA
CONCEALED HANDLE**
cromo satinato
satin chrome



**A SCOMPARSA
CONCEALED HANDLE**
nero opaco
matt black



**PUSH A FILO
FLUSH PUSH HANDLE**



WAVE
cromo satinato
satin chrome



WAVE
nero opaco
matt black



Nottolino quadro
Square turn lock
cromo satinato
satin chrome



Nottolino tondo
Round turn lock
cromo satinato
satin chrome



Nottolino tondo
Round turn lock
ottone
polished brass



Nottolino quadro
Square turn lock
nero opaco
matt black



Nottolino tondo
Round turn lock
nero opaco
matt black



**GOLA
GROOVE HANDLE**
110 cm



GOLA
a tutta altezza
GROOVE HANDLE
full-height



GOLA
verticale
18 cm
GROOVE HANDLE
vertical
18 cm



GOLA
orizzontale
18 cm
GROOVE HANDLE
horizontal
18 cm

CERNIERE HINGES



A scomparsa
ottone lucido
Cancealed hinges
polished brass



A scomparsa
cromo satinato
Cancealed hinges
satin chrome



A scomparsa
nero opaco
Cancealed hinges
matt black



Contro Piastra
ottonata
golden strike



Contro Piastra
cromo satinato
satin chrome strike



Contro Piastra
nero opaco
matt black strike

Suggerimenti per la pulizia delle porte interne

La manutenzione e la pulizia delle porte interne è semplicissima e soprattutto non necessita di prodotti particolari e costosi.

Per pulire le porte basta un semplice panno di casa inumidito con acqua e ben strizzato.

Occorre passarlo con cura in tutte le parti della porta, compresa la maniglia.

In alternativa ci sono tantissimi prodotti in commercio, basta fare attenzione che non siano troppo aggressivi, quindi privi di agenti tipo ammoniaca, candeggina, etc. Lo si spruzza direttamente sul panno e si passa su tutta la porta.

Cleaning tips

Maintaining your interior door clean is very important and easy at the same time. It doesn't involve special nor expensive products:

a simple, soft and humid rag will make the job. Just wipe it all over the door, handle included. As an alternative, you can

always rely on commercial

cleaners trying to avoid the ones containing ammonia or bleaching solutions. It's enough to spray it on the soft rag and wipe it all over the door.

INFORMAZIONI TECNICHE

Porte IMIC si riserva il diritto di apportare, senza preavviso, ogni modifica mirata al miglioramento funzionale e qualitativo dei propri prodotti.

Testi e disegni presenti in questo catalogo hanno scopo divulgativo.

I campioni colori e materiali hanno valore indicativo.

Porte IMIC reserves the right without prior notice to make adjustments to improve the efficiency and quality of our products. All text and illustrations are for advertising purposes. Colours and models shown are only an approximate indication of the product.

TIPOLOGIE DI APERTURA OPENING SYSTEMS



Porta Battente
Hinged Door

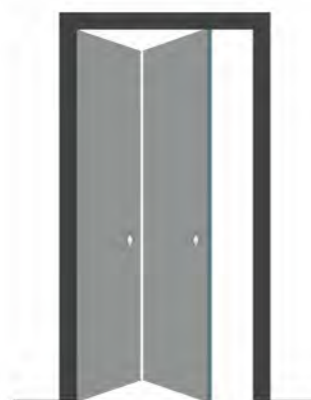

Porta a Libro
Folding Door

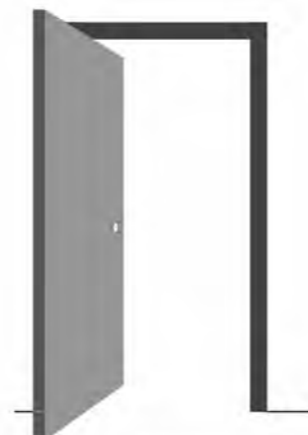

Porta Rototraslante
Pivot-Sliding Door

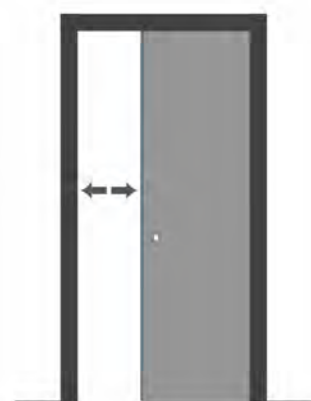

Porta Scorrevole
Interno Muro
Sliding Door Inside the Wall

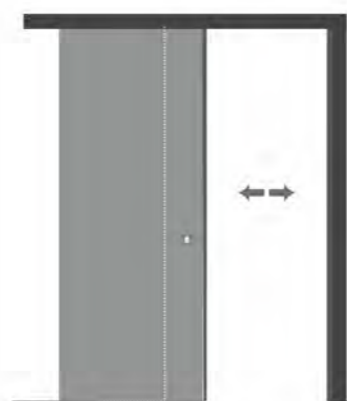

Porta Scorrevole
Esterno Muro
Sliding Door Outside the Wall



Porta Scorrevole
Esterno Muro Magic
Sliding Door Magic system

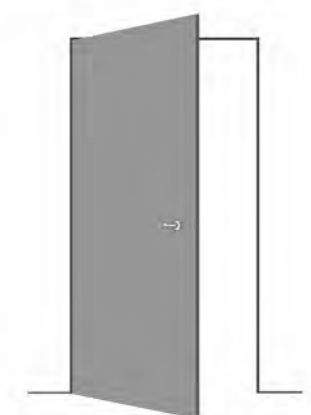

Porta Filo Muro a Tirare
Flush to Wall Door
(to Pull)

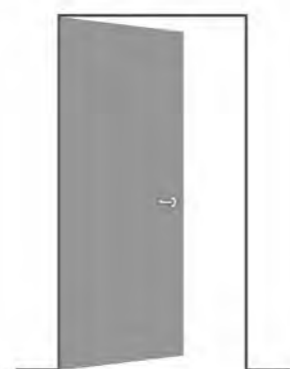

Porta Filo Muro a Spingere
Flush to Wall Door
(to Push)

STRUTTURA ANTA DOOR LEAF STRUCTURE

TRUCIOLARE FORATO
TUBULAR CHIPBOARD

LEGENDA
LEGEND

MDF IDROFUGO
WATERPROOF MDF

A

STRUTTURA PERIMETRALE IN LEGNO
LISTELLARE <<FINGER JOINT>>
<<FINGER JOINT>> STRIP

B

TRUCIOLARE FORATO
TUBULAR CHIPBOARD

C

MDF IDROFUGO
WATERPROOF MDF

D



ALVEOLARE HONEYCOMB LEAF

LEGENDA
LEGEND

MDF IDROFUGO
WATERPROOF MDF

A

STRUTTURA PERIMETRALE IN LEGNO
LISTELLARE <<FINGER JOINT>>
<<FINGER JOINT>> STRIP

B

STRUTTURA IN ALVEOLARE
HONEYCOMB STRUCTURE

C

MDF IDROFUGO
WATERPROOF MDF

D

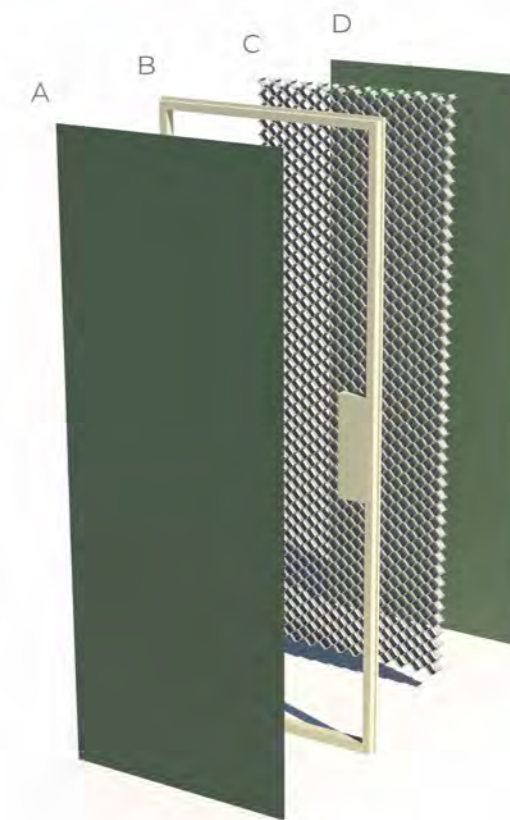

Porta battente Hinged door

Sezione orizzontale
Horizontal section



MISURE MEASUREMENT

luce netta passaggio
internal jamb clear opening
L cm 80 cm 70 cm 60 **H** cm 210

esterno stipite
external jamb
L1 cm 88 cm 78 cm 68 **H1** cm 214

interno falso telaio
internal sub-jamb
L2 cm 90 cm 80 cm 70 **H2** cm 215

esterno coprifili
external architrave
L3 cm 98 cm 88 cm 78 **H3** cm 219
L4 cm 102 cm 92 cm 82 **H4** cm 221

Sezione verticale
Vertical section

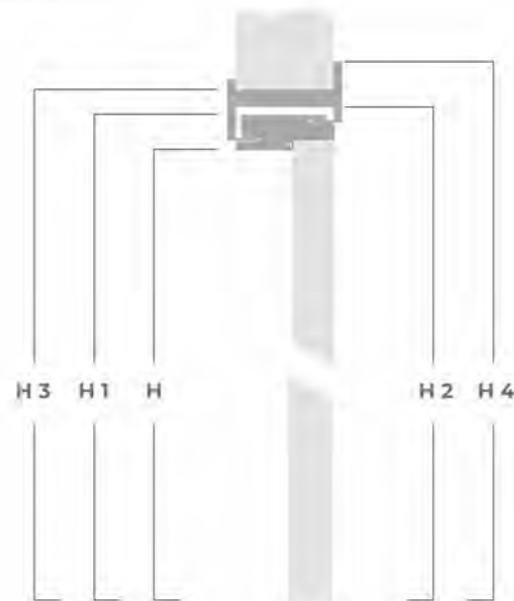

QUOTA PAVIMENTO
Floor level

Apertura Destra
Right opening



Apertura Sinistra
Left opening

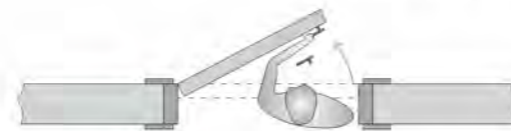

Porta complanare con apertura inversa Coplanar with reverse opening

Sezione orizzontale
Horizontal section

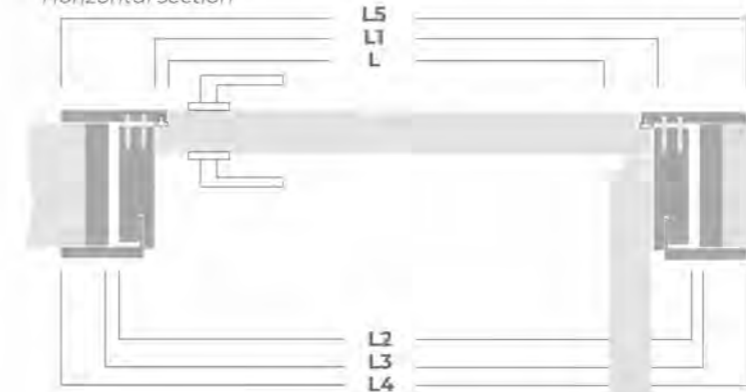

MISURE MEASUREMENT

luce netta passaggio
internal jamb clear opening
L cm 74 cm 64 cm 54 **H** cm 209

Interno stipite
internal jamb
L1 cm 80 cm 70 cm 60 **H1** cm 210

Esterno stipite
External jamb
L2 cm 88 cm 78 cm 68 **H2** cm 214

Interno falso telaio
Internal sub-jamb
L3 cm 90 cm 80 cm 70 **H3** cm 215

Esterno coprifili
External architrave
L4 cm 98 cm 88 cm 78 **H4** cm 219
L5 cm 98 cm 88 cm 78 **H5** cm 219

Sezione verticale
Vertical section

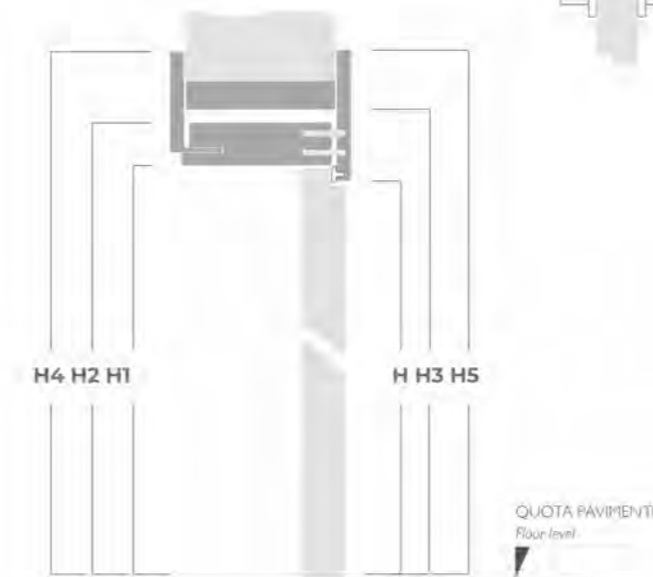

QUOTA PAVIMENTO
Floor level

Apertura Destra
Right opening



Apertura Sinistra
Left opening

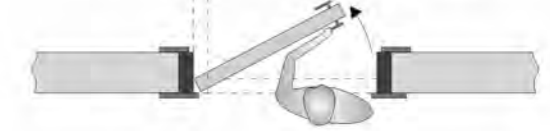

Porta scorrevole esterno muro con binario MAGIC Sliding door outside the wall MAGIC system

Sezione orizzontale
Horizontal section

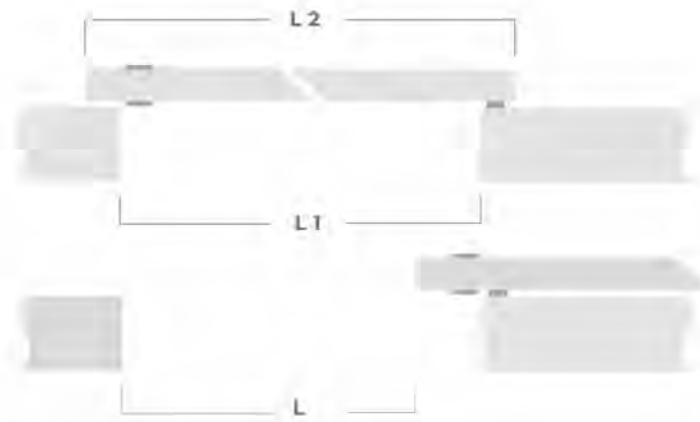

MISURE MEASUREMENT

luce netta passaggio
internal jamb clear opening
L cm 73 cm 63 cm 53 **H** cm 210

misura interno muro
internal wall size
L1 cm 80 cm 70 cm 60 **H1** cm 210

misura anta
leaf size
L2 cm 95 cm 85 cm 75 **H2** cm 220

Sezione verticale
Vertical section

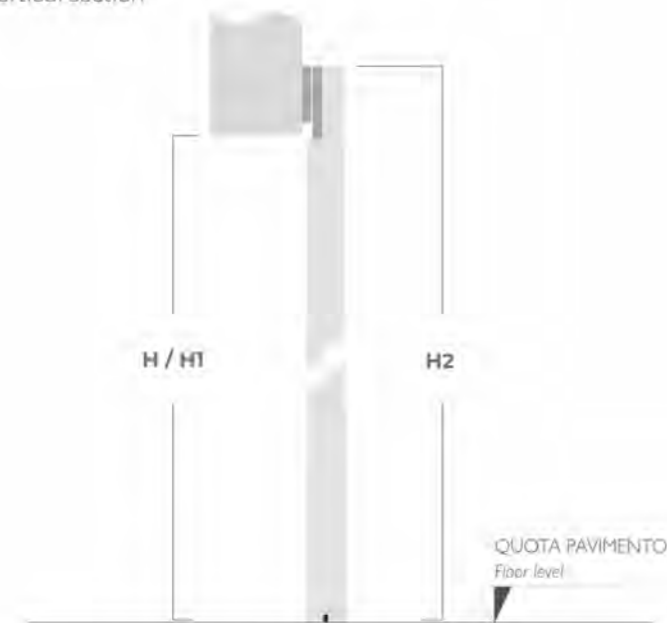

Apertura Destra
Right opening

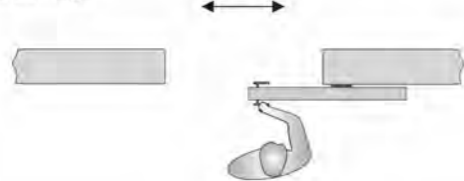

Apertura Sinistra
Left opening

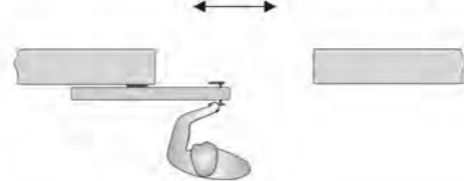

Porta scorrevole esterno muro Sliding door outside the wall

Sezione orizzontale
Horizontal section

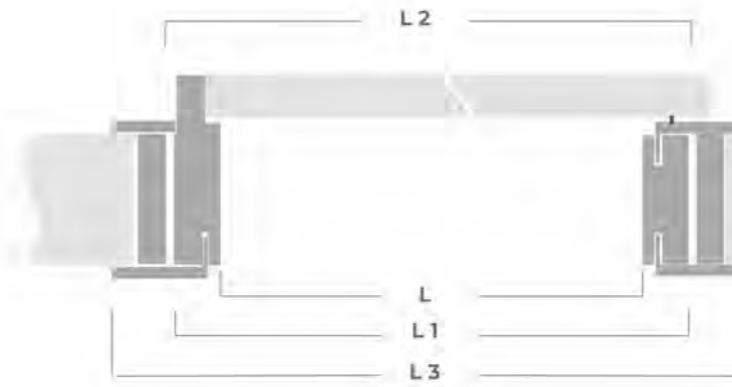

MISURE MEASUREMENT

luce netta passaggio
internal jamb clear opening
L cm 78,5 cm 68,5 cm 58,5 **H** cm 210

esterno stipite
external jamb
L1 cm 86,5 cm 76,5 cm 66,5 **H1** cm 214

interno falsotelaio
internal sub-jamb
L2 cm 88,5 cm 78,5 cm 68,5 **H2** cm 215

esterno coprifili
external architrave
L3 cm 96,5 cm 86,5 cm 76,5 **H3** cm 219

Sezione verticale
Vertical section

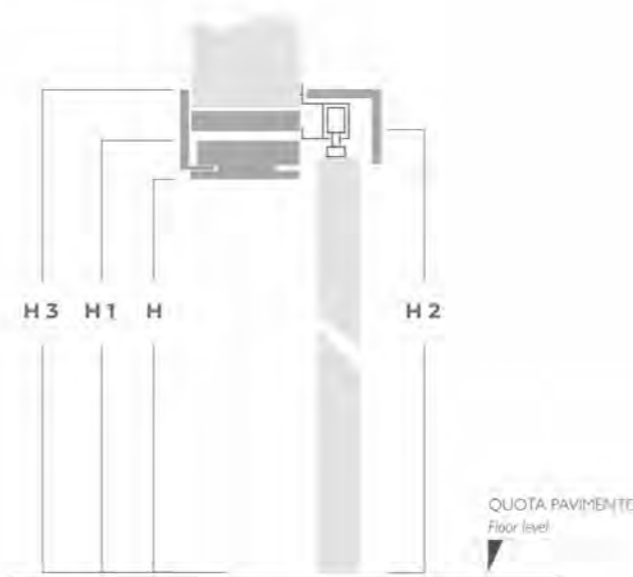

Apertura Destra
Right opening

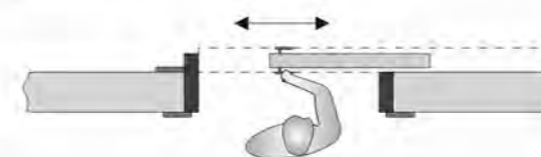

Apertura Sinistra
Left opening

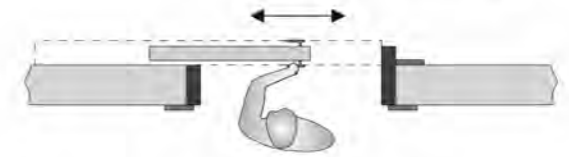

Porta a libro Folding door

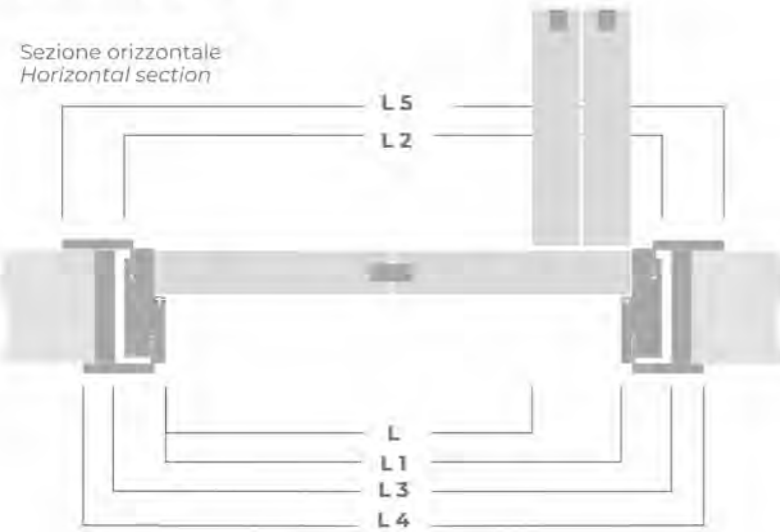

**MISURE
MEASUREMENT**

luce netta passaggio
internal jamb clear opening
L cm 72 cm 62 cm 52 H cm 210

interno stipite
internal jamb
L1 cm 80 cm 70 cm 60 H1 cm 210

Esterno stipite
External jamb
L2 cm 88 cm 78 cm 68 H2 cm 214

Interno falso telaio
Internal sub-jamb
L3 cm 90 cm 80 cm 70 H3 cm 215

Esterno coprifili
External architrave
L4 cm 98 cm 88 cm 78 H4 cm 219
L5 cm 102 cm 92 cm 82 H5 cm 221

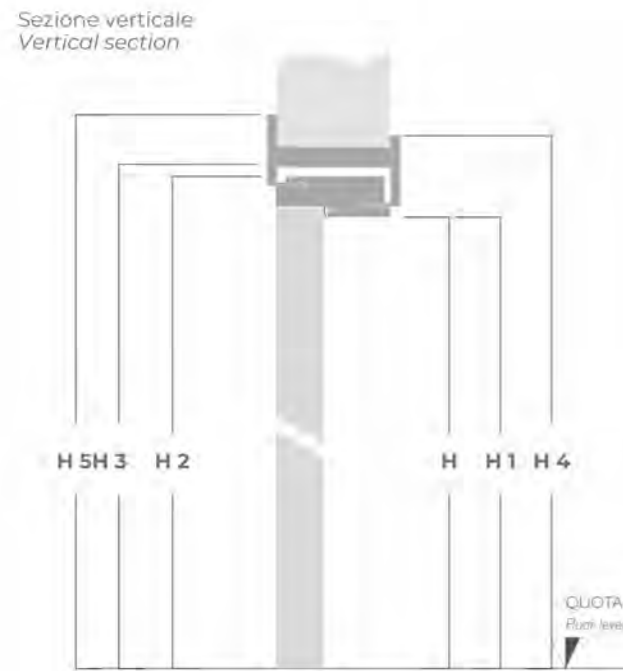

Apertura Destra
Right opening

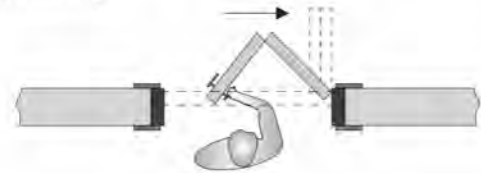

Apertura Sinistra
Left opening

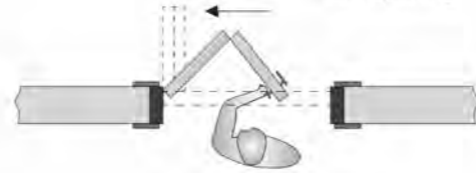

Porta a libro con apertura a 180° Folding door with 180° opening

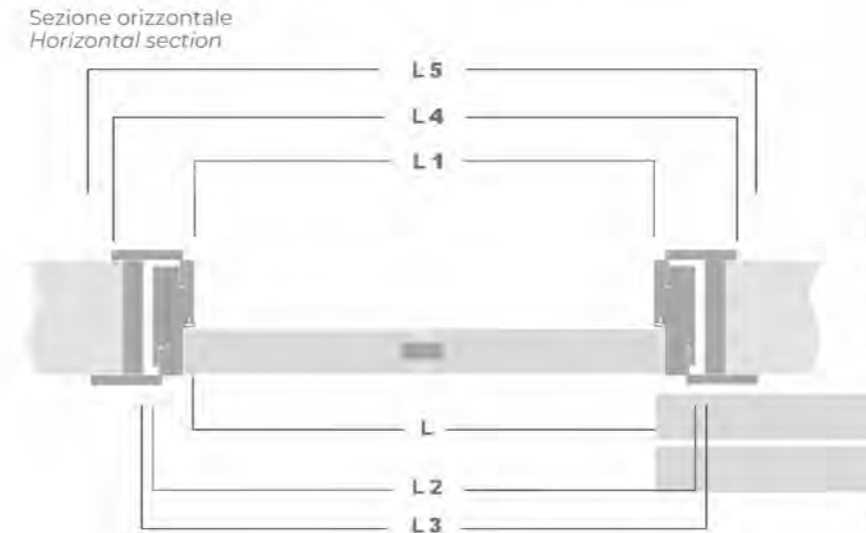

**MISURE
MEASUREMENT**

luce netta passaggio
internal jamb clear opening
L cm 79 cm 69 cm 59

Interno stipite
internal jamb
L1 cm 80 cm 70 cm 60 H1 cm 210

Esterno stipite
External jamb
L2 cm 88 cm 78 cm 68 H2 cm 214

Interno falso telaio
Internal sub-jamb
L3 cm 90 cm 80 cm 70 H3 cm 215

Esterno coprifili
External architrave
L4 cm 98 cm 88 cm 78 H4 cm 219
L5 cm 102 cm 92 cm 82 H5 cm 221

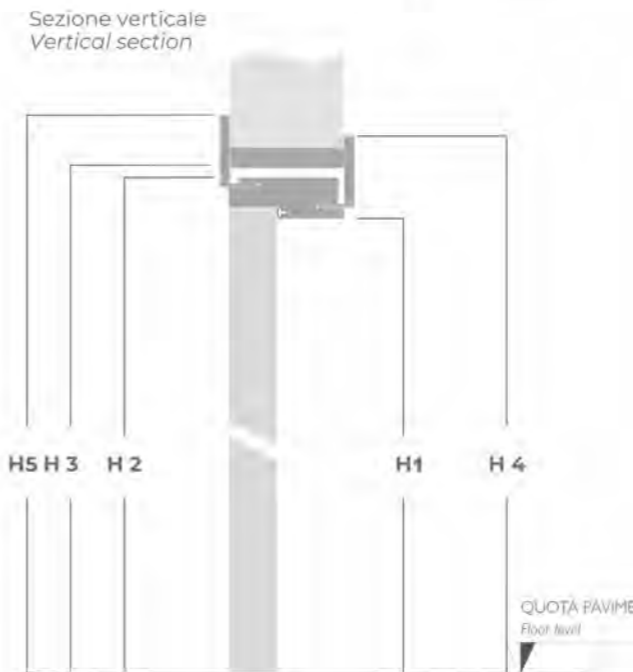

Apertura Destra
Right opening



Apertura Sinistra
Left opening



Porta rototraslante Swing door

Sezione orizzontale
Horizontal section

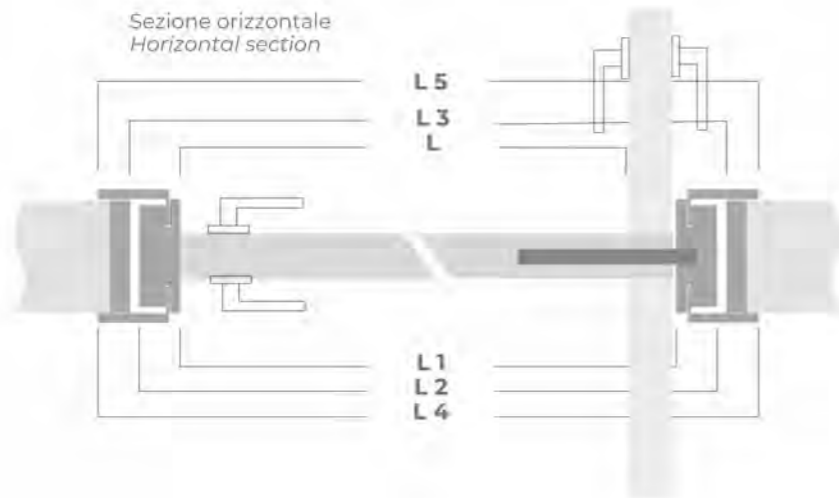

MISURE MEASUREMENT

luce netta passaggio
internal jamb clear opening

L cm 75 cm 65 cm 55 H cm 210

Interno stipite
internal jamb

L1 cm 80 cm 70 cm 60 H1 cm 210

Esterno stipite
External jamb

L2 cm 88 cm 78 cm 68 H2 cm 214

Interno falso telaio
Internal sub-jamb

L3 cm 90 cm 80 cm 70 H3 cm 215

Esterno coprifili
External architrave

L4 cm 98 cm 88 cm 78 H4 cm 219

L5 cm 98 cm 88 cm 78 H5 cm 219

Sezione verticale
Vertical section

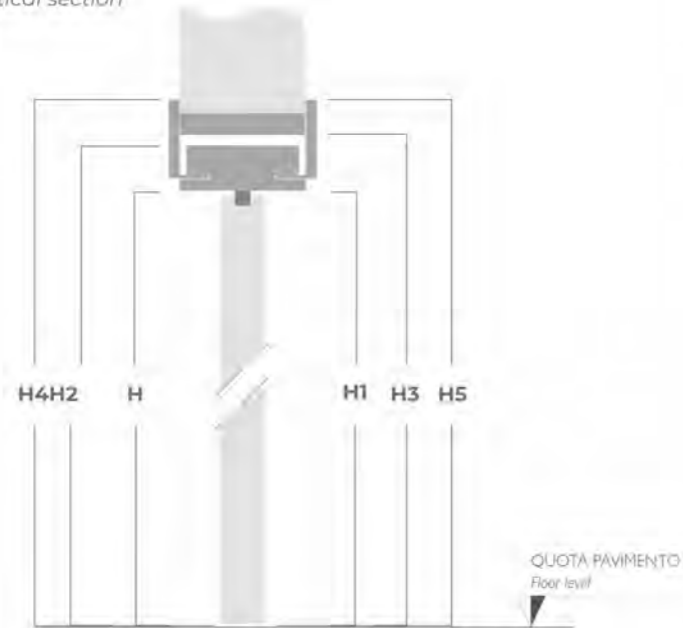

Apertura Destra
Right opening

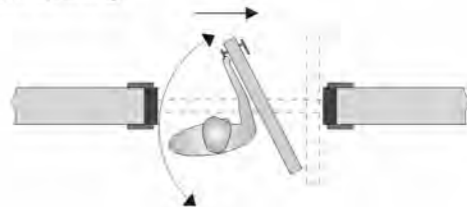

Apertura Sinistra
Left opening

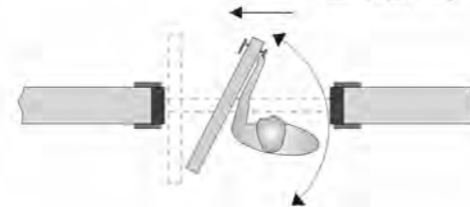

Porta scorrevole interno muro Sliding door inside the wall

Sezione orizzontale
Horizontal section



MISURE MEASUREMENT

luce netta passaggio
internal jamb clear opening

L cm 80 cm 70 cm 60 H cm 210

interno stipite
internal jamb

L1 cm 85,5 cm 75,5 cm 65,5 H1 cm 210

esterno coprifili
external architrave

L2 cm 98 cm 88 cm 78 H cm 219

Sezione verticale
Vertical section

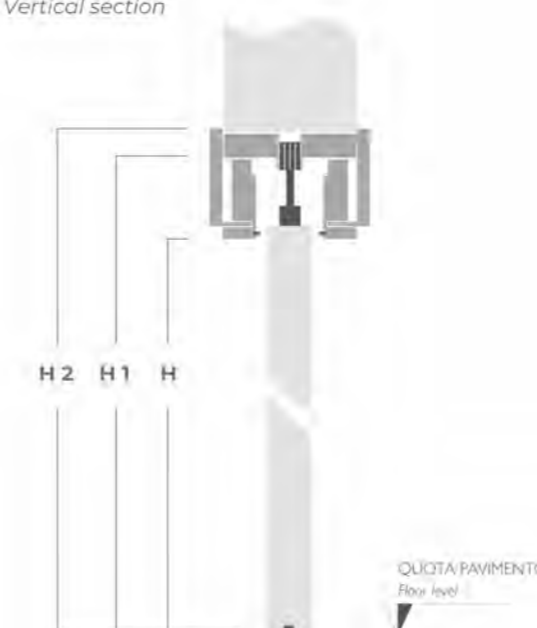

Apertura Destra
Right opening

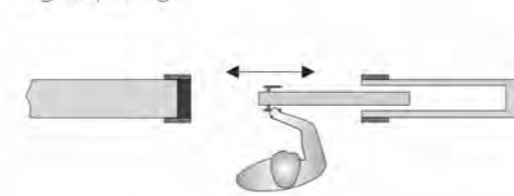

Apertura Sinistra
Left opening

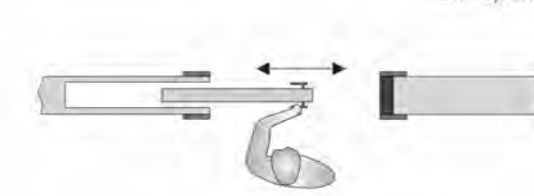

Porta Filo muro Flush to wall door

Sezione orizzontale
Horizontal section

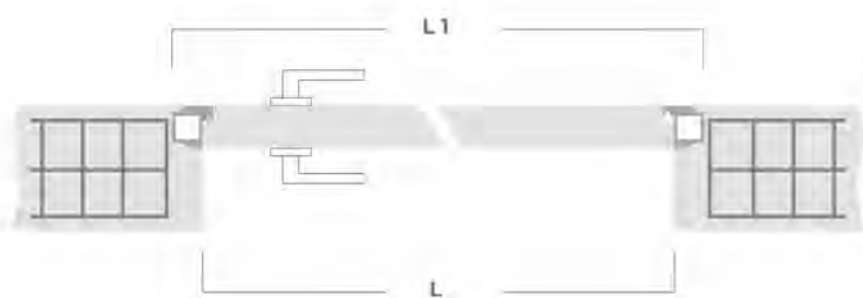

MISURE MEASUREMENT

luce netta passaggio
internal jamb clear opening

L cm 80 cm 70 cm 60 **H** cm 210

Luce muratura
wall opening

L1 cm 90 cm 80 cm 70 cm 215

Sezione verticale
Vertical section

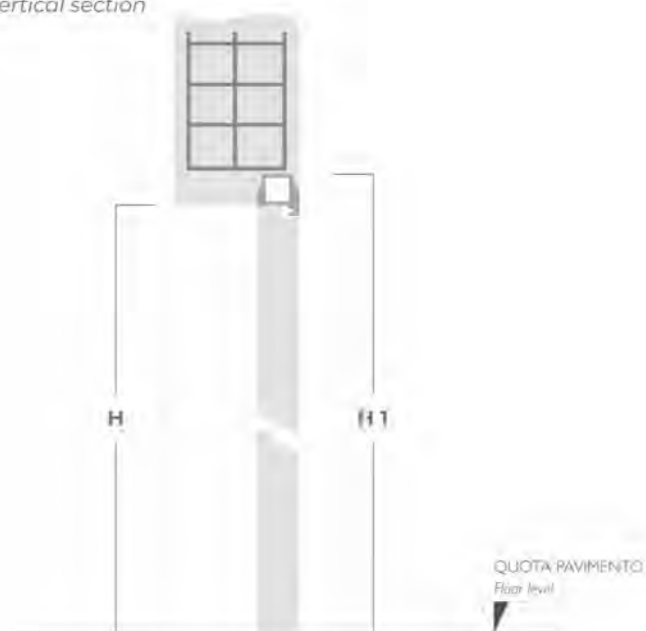

Apertura Destra
Right opening



Apertura Sinistra
Left opening



TIPOLOGIE STIPITI E COPRIFILI

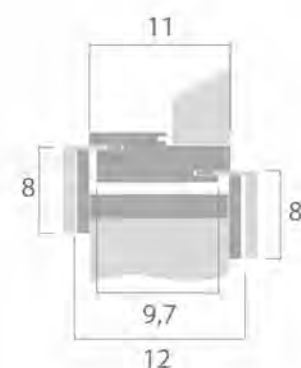

Stipite telescopico da 11 cm
 coprifilo da 8 cm lato esterno e lato interno con aletta da 2,5 cm
 11 cm Telescopic jamb
 internal and external 8 cm architrave with 2,5 cm wing

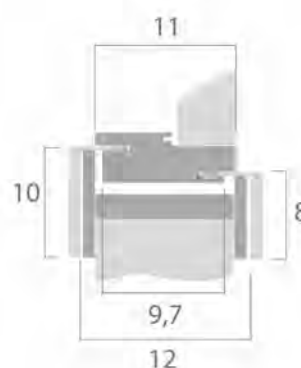

Stipite telescopico da 11 cm
 coprifilo da 10 cm lato esterno e coprifilo da 8 cm lato interno con
 aletta da 2,5 cm
 11 cm Telescopic jamb
 external 10 cm architrave, internal 8 cm architrave with 2,5 cm wing

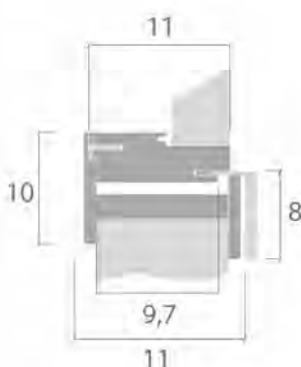

Stipite telescopico da 11 cm
 coprifilo da 10 cm lato esterno senza aletta e coprifilo da 8 cm lato interno con
 aletta da 2,5 cm
 11 cm Telescopic jamb
 external 10 cm architrave without wing, internal 8 cm architrave with 2,5 cm wing

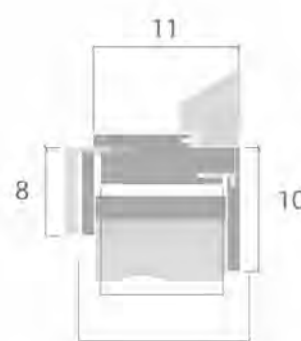

Stipite telescopico da 11 cm
 coprifilo da 8 cm lato esterno con aletta da 2,5 cm, coprifilo da 10 cm, lato interno
 senza aletta (versione plana)
 11 cm Telescopic jamb
 external 8 cm architrave with 2,5 cm wing, internal 10 cm
 architrave without wing (plana version)

TIPOLOGIE STIPITI E COPRIFILI

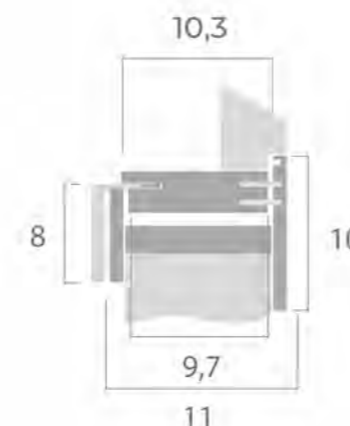

Stipite telescopico da 11 cm
 coprifilo da 8 cm lato esterno con aletta da 2,5 cm
 coprifilo da 10 cm lato interno senza aletta
 (versione complanare con apertura inversa)
 11 cm Telescopic jamb
 external 8 cm architrave with 2,5 cm wing
 internal 10 cm architrave without wing (coplanar with reverse opening)

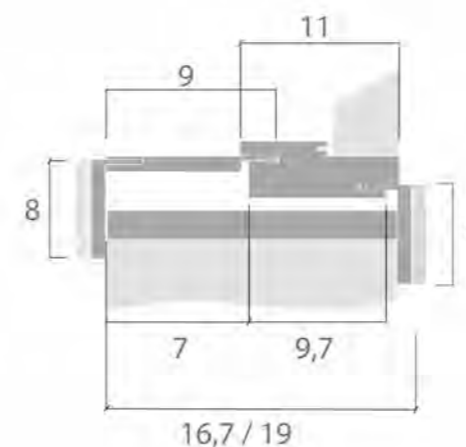

Stipite telescopico da 11 cm
 coprifilo da 8 cm lato esterno e lato interno con aletta da 2,5 cm
 11 cm Telescopic jamb
 internal and external 8 cm architrave with 2,5 cm wing

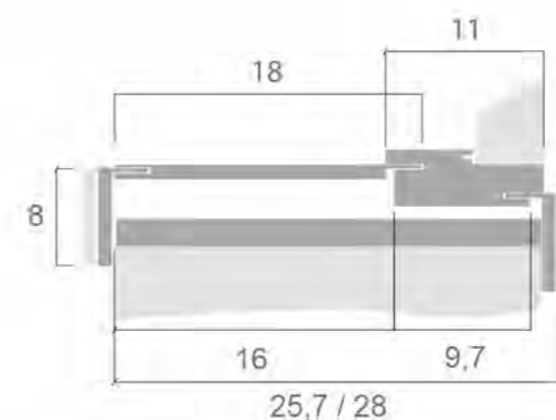

Stipite telescopico da 11 cm con imbottito da 18 cm (Optional)
 coprifilo da 8 cm lato esterno e lato interno con aletta da 2,5 cm
 11 cm Telescopic jamb with 18 cm extension (Optional),
 internal and external 8 cm architrave with 2,5 cm wing

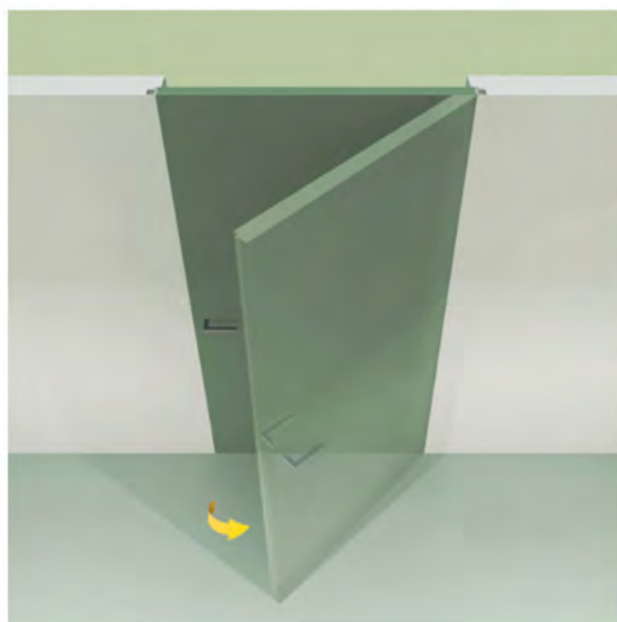

Porta filomuro lato esterno,
apertura a tirare
Flush to wall door with outside
pull opening

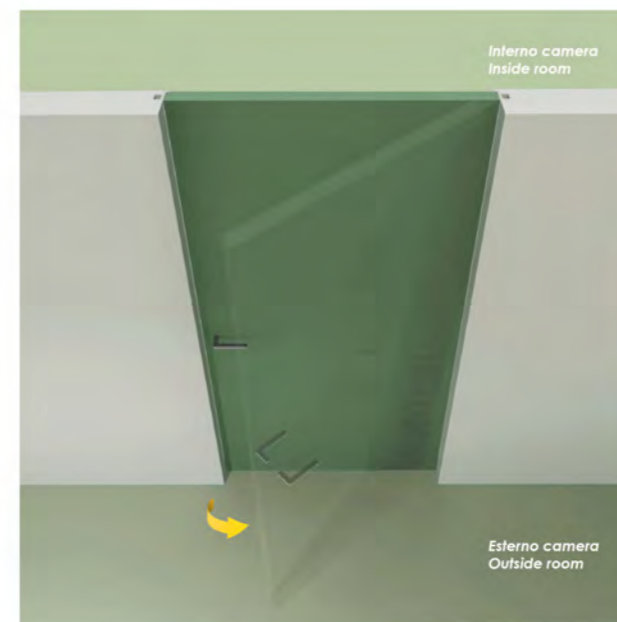

Porta filomuro lato interno,
apertura a tirare
Flush to wall door with inside
pull opening

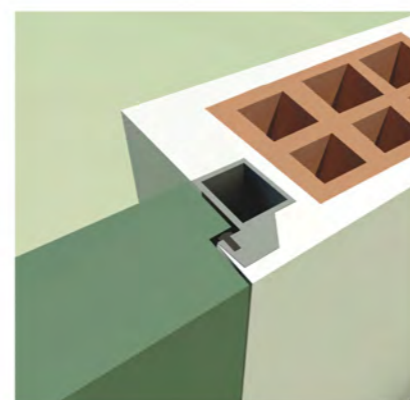
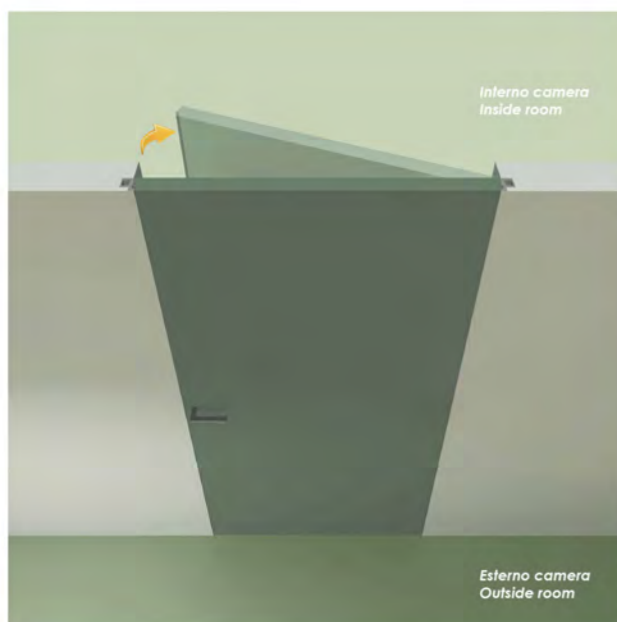

Porta filomuro lato esterno,
apertura a spingere
Flush to wall door with outside
push opening

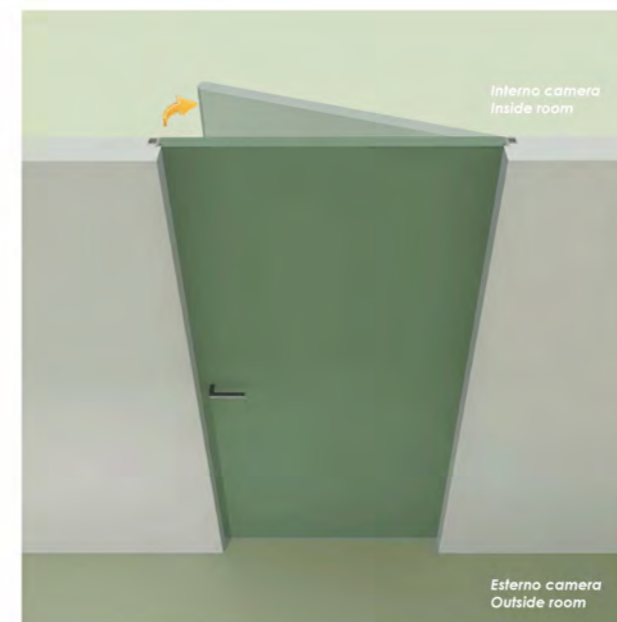

Porta filomuro lato interno,
apertura a spingere
Flush to wall door with inside
push opening

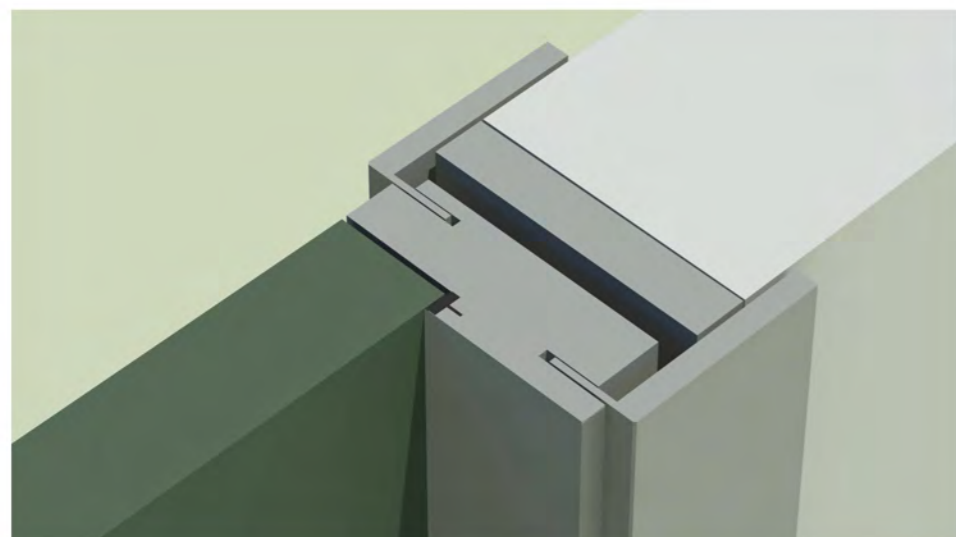

Sezione porta a battente con
cerniere a scomparsa

*Section of hinged door with
concealed hinges*

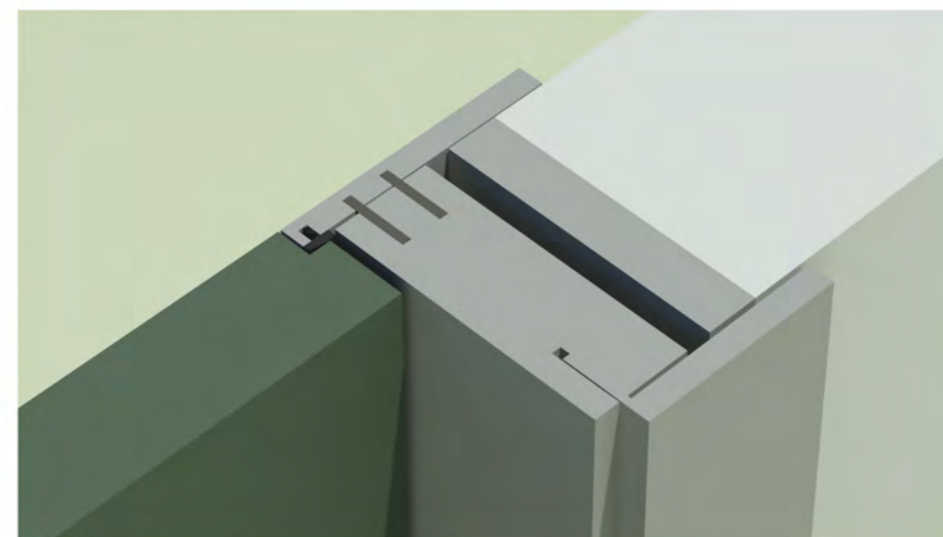

Sezione porta coplanare
con apertura inversa

*Section of hinged door Coplanar
with reverse opening*

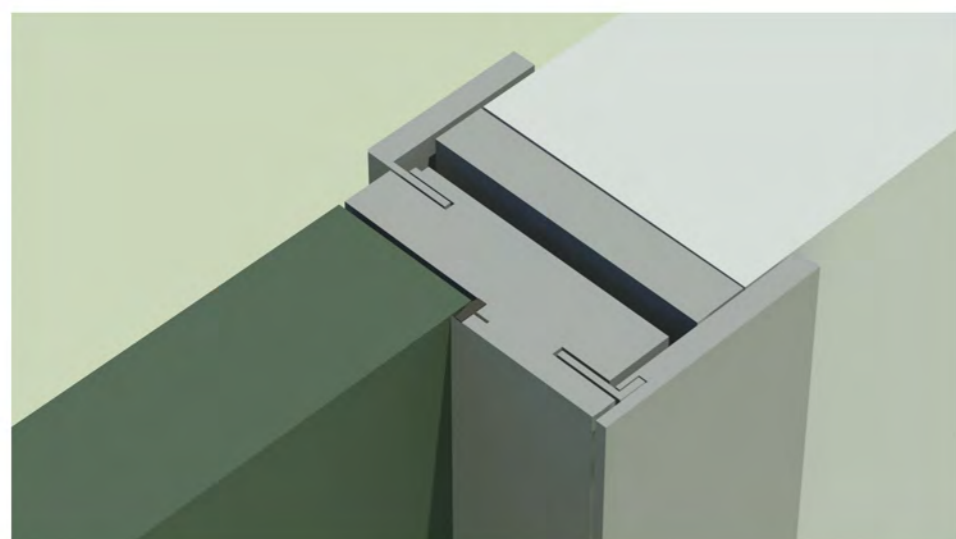

Sezione porta a battente con
coprifilo esterno da 10 cm

*Section of hinged door with external
architrave from 10 cm*

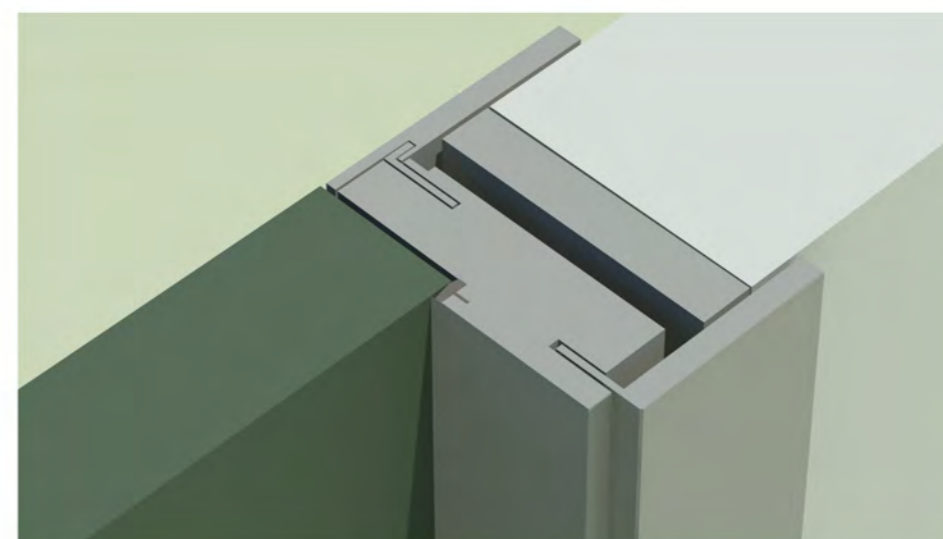

Sezione porta a battente
versione "plana"

*Section of hinged door «plana»
version*

NOTE:

COORDINATION,
CONCEPT AND DESIGN:
ARCH. CONO CERAOLO

PHOTOGRAPHER:
NINO BARTUCCIO

GRAFIC DESIGNER:
NANCY RIZZO
CRAYONART DESIGN STUDIO



PORTE IMIC SPA

SEDE E STABILIMENTO:
VIA CONTRADA ZAPPULLA - 98070 TORRENOVA
(MESSINA) ITALIA
TEL. +39 0941 958266 PBX
TELEFAX +39 0941 958485
info@porteimic.com
porteimic.com